

Article number: 03486010
 Description: Fluro Rod end EAL 10D
 Note: 10

Measures

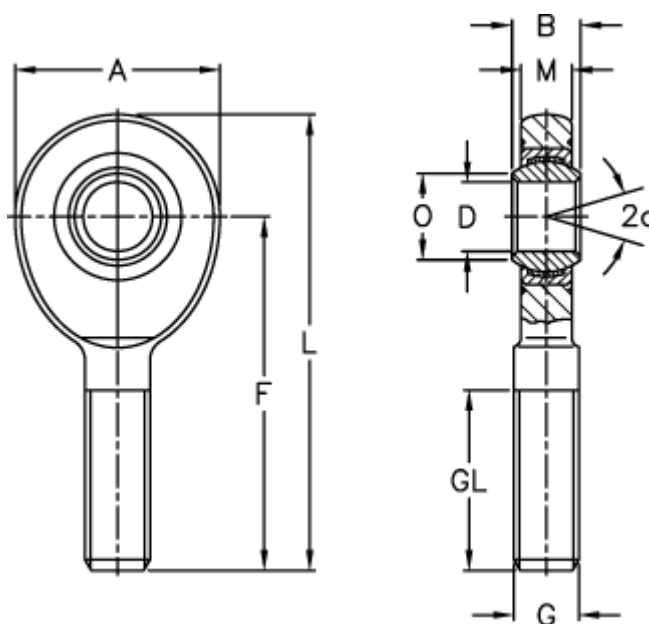

A	= 28	L	= 62
a (degrees)	= 12	M	= 7
B	= 9	O	= 13.2
D	= 10	Static drive kN	= 19.9
Dynamic drive (kN)	= 8.6	Weight	= 50
F	= 48		
g	= M 10		
GL	= 26		